

# GS610

Source Measure Unit



- Basic accuracy: 0.02%
- Wide output range: 110 V, 3.2 A
- High speed source capability : 100 $\mu$ s/point
- USB storage function
- Web Server (Ethernet option)

## ■ Application Examples

- Measurement of basic electrical characteristics of semiconductor devices
- Supply voltage fluctuation test of portable or in-vehicle devices
- Pulse current drive for LED and organic EL
- Charge/Discharge characteristics test of batteries
- Power conversion efficiency measurement of DC-DC converters
- Pass/Fail judgment test for resistors, thermistors, varistors, etc.

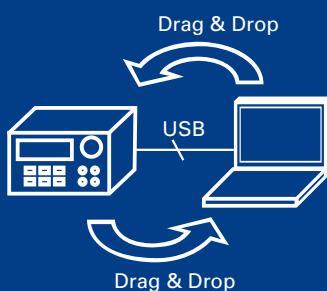

**USB STORAGE**

# Combines YOKOGAWA's DC technologies and consolidates high accuracy and high speed in a single unit

The GS610 is a highly accurate and highly functional programmable voltage/current source that incorporates voltage/current generation and measurement functions. The maximum output voltage and current are 110 V and 3.2 A, respectively. Evaluation of over a wide range of basic electrical characteristics is possible, because the GS610 can operate as a current source or a current sink.

## GS610 Source Measure Unit



### Features

- Source and sink operation up to 110 V/3.2 A (four-quadrant operation)
- Basic accuracy:  $\pm 0.02\%$ \*1
- Sweep output at up to 100 $\mu$ s intervals
- Comes with abundant sweep patterns (linear, logarithmic, and arbitrary)
- Stores up to 65535 points of source measure data in the internal memory
- Easy file operation with the USB storage function
- Remote control and FTP using Web Server Function (Optional)

\*1: DC voltage generation

### Voltage/Current Generation and Measurement Range

Four-dimensional operation with source operation (current source) and sink operation (current sink) is possible at up to 110 V, 3.2 A, and 60 W. The output and measurement resolutions are 5.5 digits.

Voltage generation/measurement range: 200 mV to 110 V  
 Current generation/measurement range: 20  $\mu$ A to 3.2 A

Maximum output current:

- $\pm 3.2$  A (at an output voltage of  $\pm 12$  V or less)
- $\pm 2$  A (at an output voltage of  $\pm 30$  V or less)
- $\pm 1$  A (at an output voltage of  $\pm 60$  V or less)
- $\pm 0.5$  A (at an output voltage of  $\pm 110$  V or less)

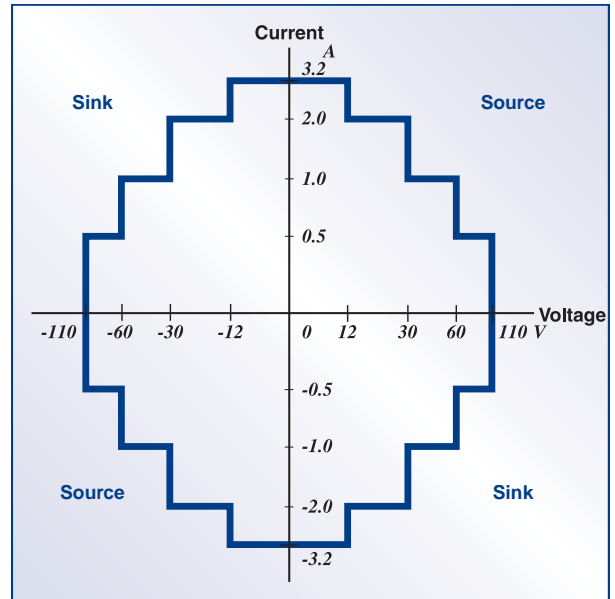

### Generation and Measurement Functions

The GS610 is made up of a constant current source, a constant voltage source, a voltmeter, and an ammeter. Each function can be combined into numerous operation modes.

#### Operation modes:

- Voltage generation/current measurement (VS/IM);
  - Voltage generation/voltage measurement (VS/VM);
  - Current generation/voltage measurement (IS/VM);
  - Current generation/current measurement (IS/IM);
  - Voltage generation (VS); Current generation (IS); and Resistance measurement (VS/IM or IS/VM)
- Additionally, control and measurement using a two-wire system or a four-wire system are possible by switching local sensing and remote sensing internally.

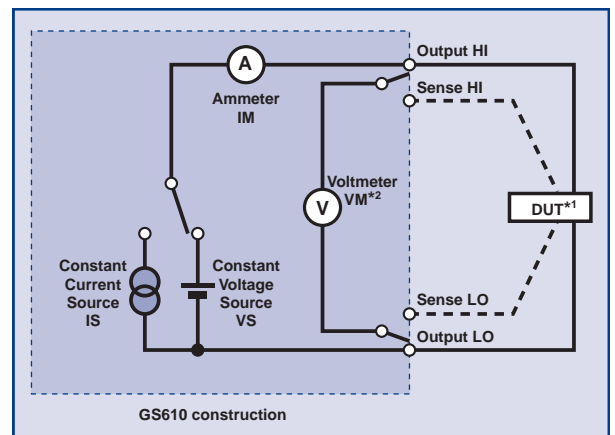

--- four-wire system  
 \*1: DUT: Device Under the Test  
 \*2: For DUT voltage measurement.

### Various Operation Modes

The voltage/current generation block of the GS610 operates in DC generation mode or pulse generation mode. Four operation modes--continuous output, linear sweep, log sweep, and program sweep--are available for each generation mode. In program sweep mode, the user can define an arbitrary sweep pattern. The output level can be changed at a minimum of 100 $\mu$ s intervals in each sweep mode.

#### DC output mode

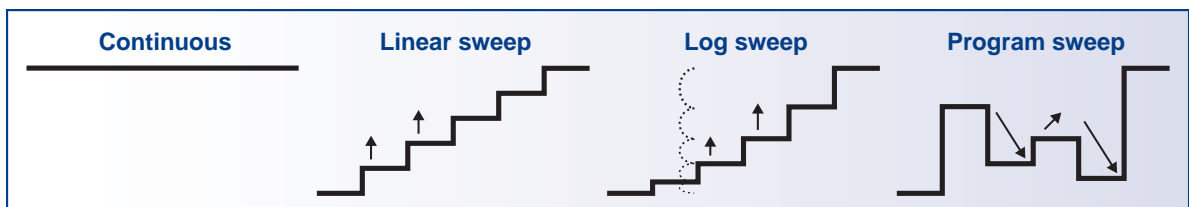

#### Pulse output mode

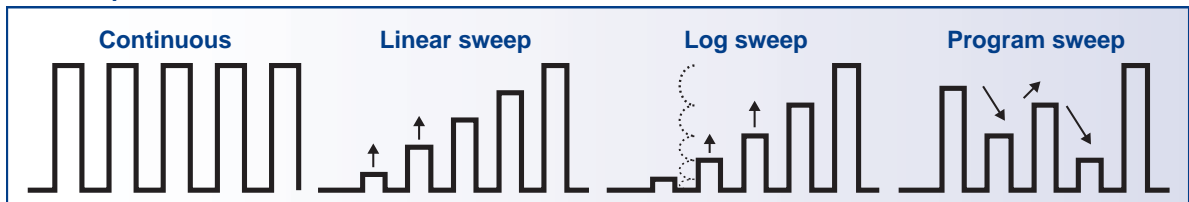

Generation and Measurement Timing (Source Measure Cycle)

Source measure cycle (source & measure at 1 ms minimum)

As shown in the figure below, the GS610 is capable of synchronizing the generation and measurement at any operation mode. Generation is started after a source delay with respect to an internal/external trigger. Then, after the time it takes for the source level to stabilize (measure delay) the measurement is carried out over a given integration time. This function is necessary when making measurements by waiting for the load response after applying a pulse. The source measure cycle is the minimum unit for signal generation and measurement. The source/measurement operation (source measurement cycle) on the GS610 is 1 ms minimum.

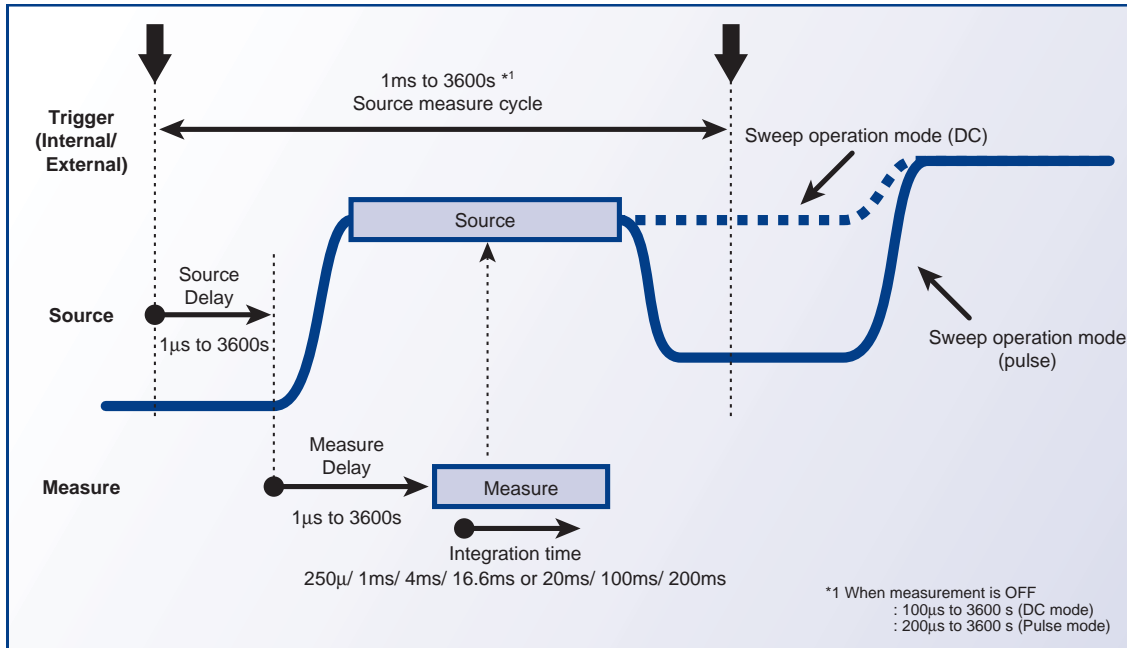

Difference Measurement Using the Sweep Operation

The sweep operation can be used to make two measurements, then the difference between the two measurements can be determined. When the source value of sweep data 1 is established, the first measurement is carried out. Then, when the source value of sweep data 2 is established, the second measurement is carried out. The difference is determined by subtracting the value of the second measurement from that of the first measurement. By carrying out the two measurements within a short time, highly accurate measurements are possible with the effects of offset fluctuation cancelled. In addition, by applying a voltage with equal magnitude but opposite in polarity (source 1 = -1 × source 2), the effects of offset error caused by the thermo electromotive force at the junction can be cancelled.

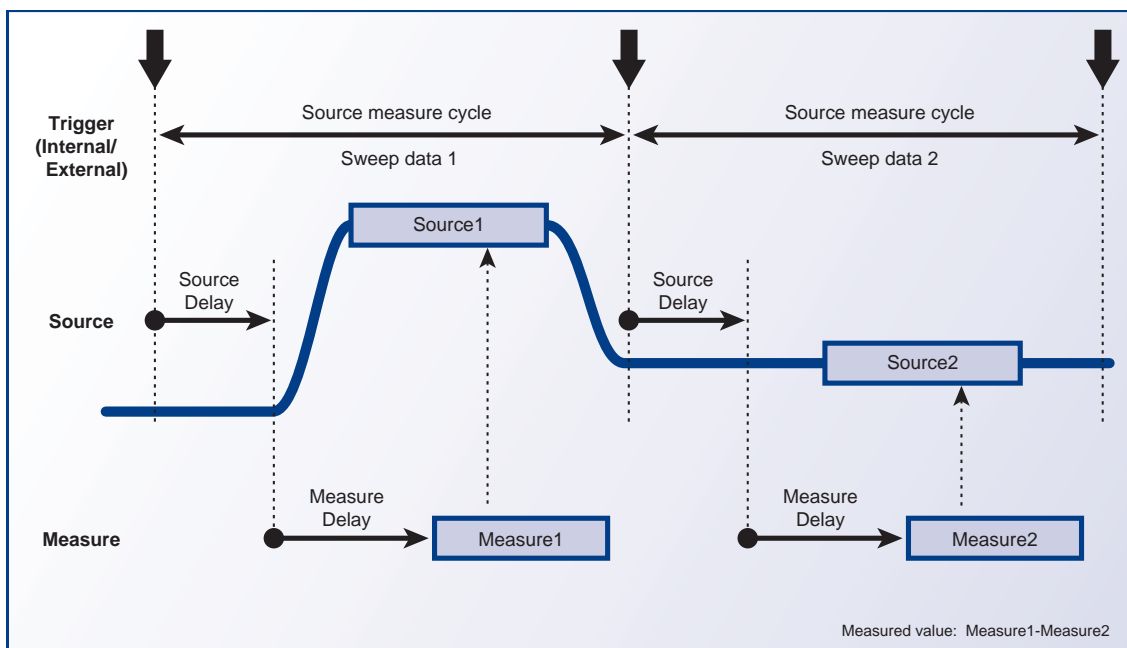



### Zero Generation Function of Voltage and Current

The zero generation function of the GS610 enables the generation of the voltage/current zero value as well as the switching of the output condition between high and low impedance. In the zero generation condition, the voltage application or current supply to the load can be stopped with the output relay turned ON. This function avoids the problems of chattering and contact life of the output relay and reduces the ON/OFF operation time of the output.

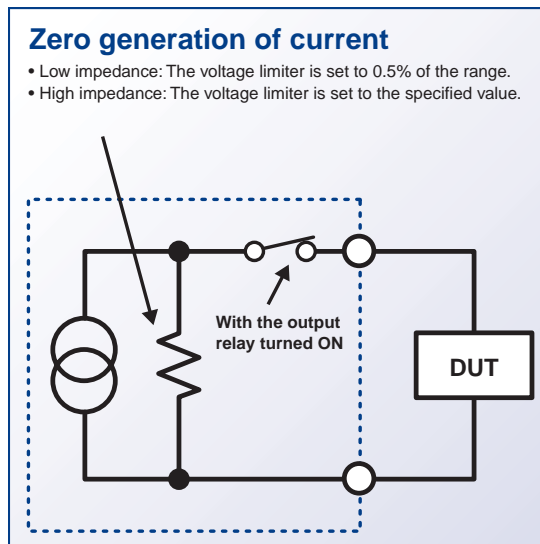
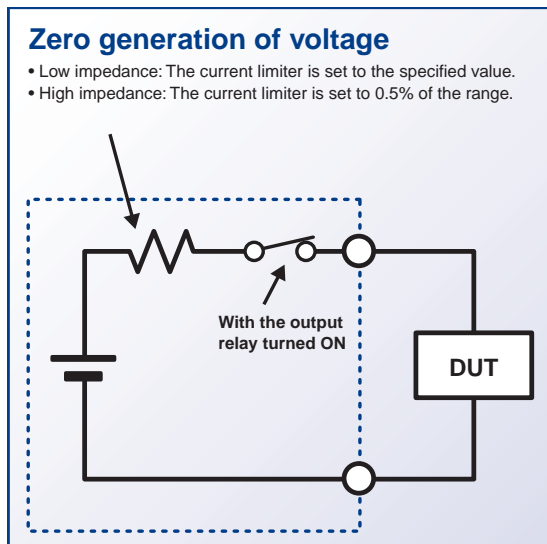

### External Input/Output and Synchronized Operation

The GS610 has various external input/output connectors. Signals such as the trigger input/output indicating the timing of generation and measurement, the output relay ON/OFF control signal, the zero generation ON/OFF control signal, and the comparator judgment result output can be input/output from the BNC and multi-core connectors. In addition, multiple GS610s can be synchronized by simply connecting the trigger output of a GS610 to the trigger input of another GS610 using a BNC cable.

(For the external view of the connector type, see the "Rear Panel" section on page 7.)

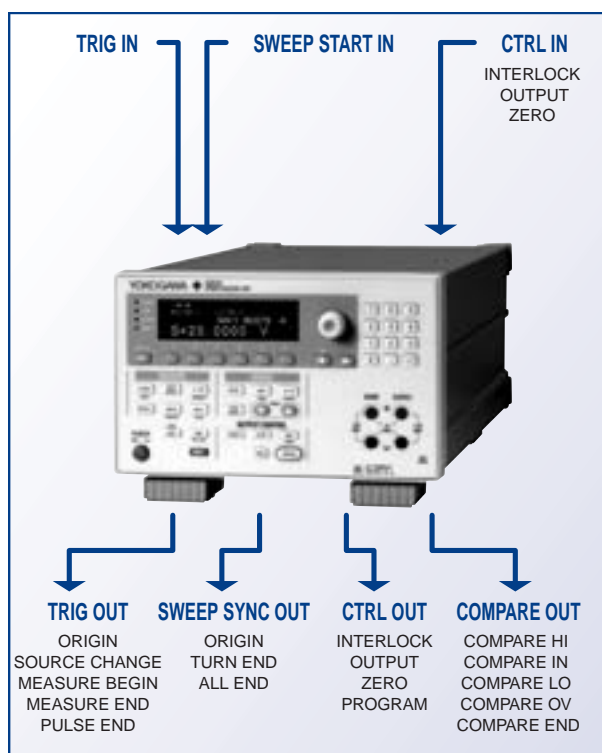

Signal Name		Function
TRIG IN		Trigger input
SWEEP START IN		Sweep start input
CTRL IN	INTERLOCK	Interlock input
	OUTPUT	Relay control input
	ZERO	Zero generation control input
TRIG OUT	ORIGIN	Trigger output
	SOURCE CHANGE	Source change timing output
	MEASURE BEGIN	Measure start timing output
	MEASURE END	Measure end timing output
	PULSE END	Pulse falling edge timing output
SWEEP SYNC OUT	ORIGIN	Sweep synchronization output
	TURN END	Sweep 1 turn end timing output
	ALL END	Sweep all end timing output
CTRL OUT	INTERLOCK	Interlock through output
	OUTPUT	Relay status output
	ZERO	Zero generation status output
	PROGRAM	Programmable output
COMPARE HI		Comparison result output HIGH
COMPARE IN		Comparison result output IN
COMPARE LO		Comparison result output LOW
COMPARE OV		Comparison result output OVERRANGE
COMPARE END		Compare end

Easy File Operation with the USB Storage Function

When the GS610 Source Measure Unit is connected to a PC via the USB, the PC detects the GS610 internal memory as a USB storage device. A pattern file can easily be stored in the GS610 internal memory by creating the GS610 generation pattern on a general-purpose worksheet application (1) and dragging and dropping the pattern file (2). The GS610 sweeps the voltage or current levels according to the generation pattern that is written in this file, measures the load current or load voltage at the appropriate points (3), and stores the results to the GS610 internal memory (4). A measurement result file can be retrieved into the PC by dragging and dropping. There is absolutely no cumbersome programming or installation of dedicated software programs required (5) and (6).

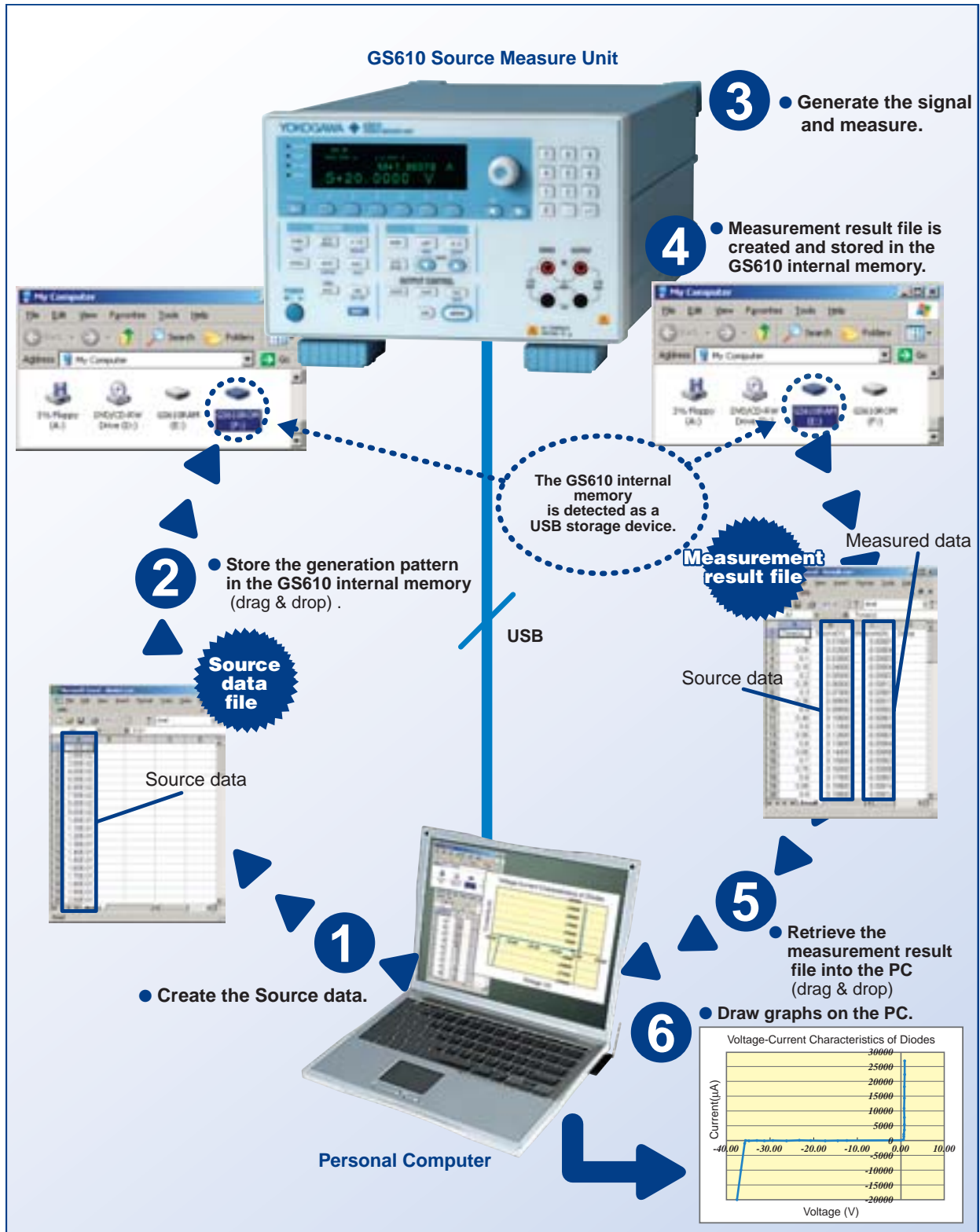

### User-Defined Computation Function

User-defined computation can be performed on the GS610 by combining dedicated operators. It can be used to carry out linear conversion of measured values, compute the power, compute the next generated value from the current measured value, and perform real-time computation of generated data using expressions. The expression is created using a text editor on your PC and stored to the GS610 internal memory via the USB.

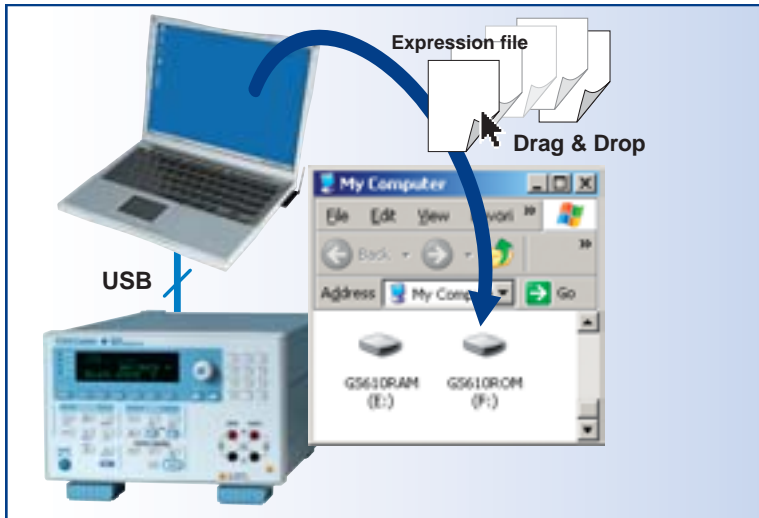

#### Linear conversion

$$m = A * m + B \quad A, B: \text{constant.}$$

$m$ : Measured value  
 $m$ : Measured value after computation

#### Calculation of the next generated value

$$s = 3.6 / m \quad (\text{used for constant output power, etc.})$$

$s$ : Next generated value  
 $m$ : Measured value

#### Sine wave generation

$$x0 = 0 \quad \begin{array}{l} x0 : \text{Initial value of variable } x \\ x : \text{Variable} \\ A, B, C: \text{Constant} \end{array}$$

$$s = A * \sin(2 * \pi * x / C) + B$$

$$x = x + 1$$

### Ethernet Interface (/C10 Option)

Remote control and file transfer can be carried out over the network by installing the Ethernet Interface (/C10 option).

#### Web Server

The GS610 connected via the Ethernet interface can be controlled from Internet Explorer.

#### Remote control

Displays a front panel image of the GS610 on the browser with which the GS610 can be remotely controlled.

#### File transfer

The GS610 internal memory can be handled as a PC file server. The output pattern can be transferred to the GS610 internal memory, or the measurement result data can be loaded in the PC.

Screen image of the Web Server function



Screen image of the Remote Panel

#### Command control function

The GS610 can be controlled using commands similar to GP-IB or RS232 commands.

Up to five clients can connect to the GS610.

### Rear panel

#### Trigger/sweep/control input (BNC connector)

Select trigger input, sweep start input, or control input.

#### Trigger/sweep/control output (BNC connector)

Select trigger output, sweep start output, or control output.

#### Ethernet (/C10 option)

Complies with 100BASE-TX/10BASE-T. Can be used to carry out FTP file transfer.

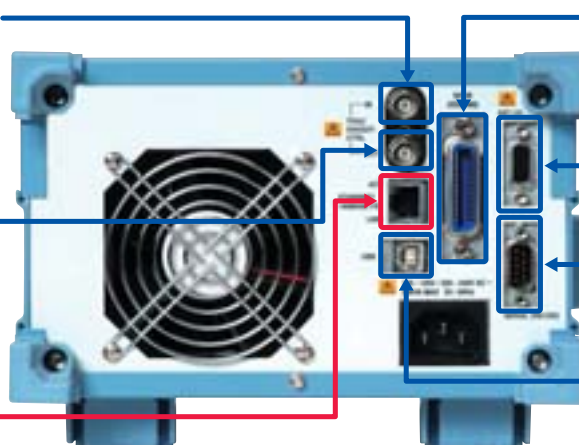

#### GP-IB

An interface used to remotely control the GS610 from a PC (IEEE 488 compliant).

#### External input/output

Synchronization control signal with other devices and comparator judgment result output.

#### Serial (RS-232)

#### USB-PC connection

Used to connect to a PC and enable the GS610 internal memory to operate as a USB storage device.

Measurement of the Static Characteristics of Semiconductor Devices (Diode, Tr, FET, etc.)

Two GS610s are operated in sync to measure the static characteristics of a transistor. Then, constant h is determined from the slope of each characteristics data. In the  $I_B$ - $I_C$  characteristics measurement, a GS610 for base current  $I_B$  output and a GS610 for collector current  $I_C$  measurement are operated in sync to measure the characteristics. The  $V_{CE}$ - $I_C$  characteristics measurement is possible using one GS610 by connecting the GS610 between the emitter and the collector, applying  $V_{CE}$ , and measuring the collector current  $I_C$ .

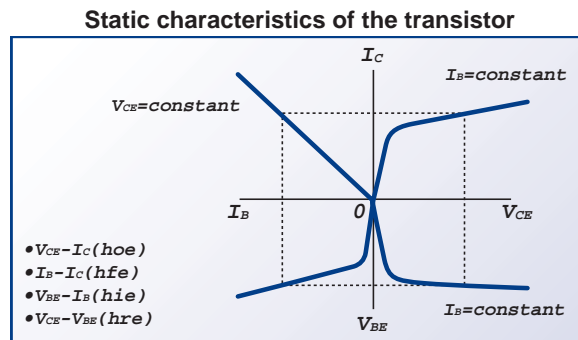
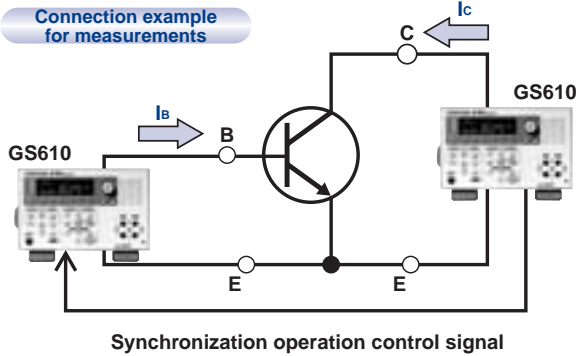

Voltage Fluctuation Simulation of Electronic Devices and Sensors for Vehicles

The power supply of automobiles (12 V or 24 V) fluctuates greatly with voltage degradation, superimposed spike noise, etc. It is a harsh environment for in-vehicle electronic devices. For example, the voltage degrades when the air conditioner starts or spike noise is superimposed when the wiper motor starts. The supply voltage fluctuates constantly affecting the operation of in-vehicle devices. In the past, supply voltage fluctuation test of in-vehicle devices needed to be carried out with the device installed in the automobile. The USB storage function of the GS610 enables waveform data of degraded voltage and spike noise to be easily acquired and output. Therefore, the supply voltage fluctuation similar to the fluctuation in the actual automobile can be reproduced in the laboratory for testing, eliminating the need to install the device under test in the automobile. In addition, by capturing the supply voltage fluctuation waveform with a digital oscilloscope and storing the waveform data in the GS610 internal memory, the actual supply voltage fluctuation waveform can be easily reproduced.

Voltage fluctuation and superimposed noise of batteries

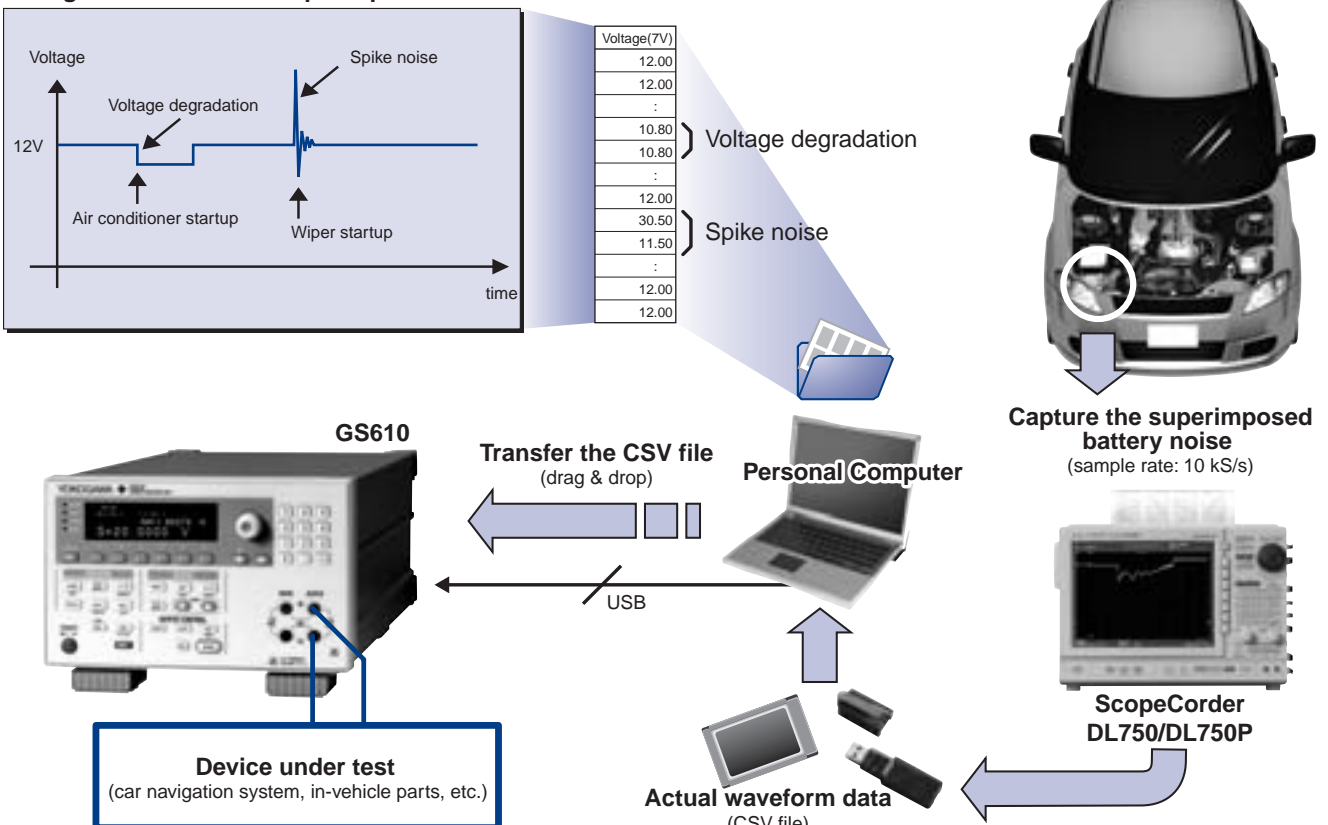



### Charge/Discharge Characteristics Measurement of Secondary Batteries (Lithium-Ion or Nickel-Hydride)

The GS610 can be used to simulate the charge/discharge operation of secondary batteries such as lithium-ion and nickel-hydride batteries. In boost charge operation, constant current charge is carried out using large current in the range of approximately 2C to 5C (2 to 5 times the battery capacity). When the battery voltage reaches a given value, a switch is made to constant voltage operation. In constant voltage charge operation, the charge current gradually decreases. When it decreases to a given value, the charge operation is stopped. The GS610 has an auto V/I function that automatically switches from battery voltage measurement to charge current measurement in sync with the switching of the operation mode from constant current charge to constant voltage charge. In the discharge simulation, constant current pulse discharge is possible through the GS610 pulse current sink operation. This enables simulation that takes into account the intermittent operation of mobile devices.

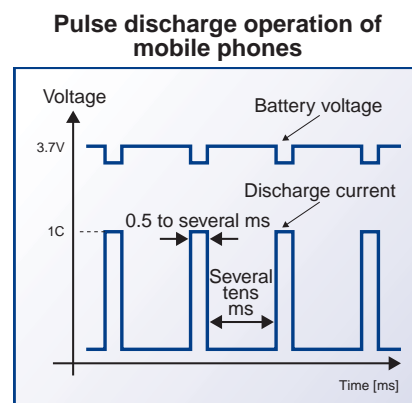
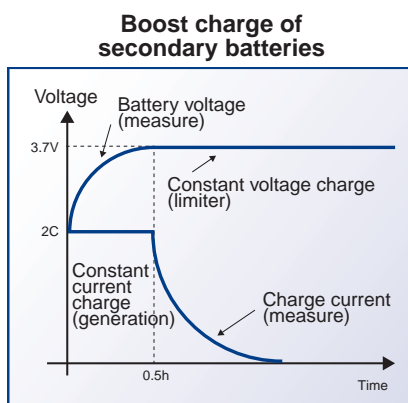
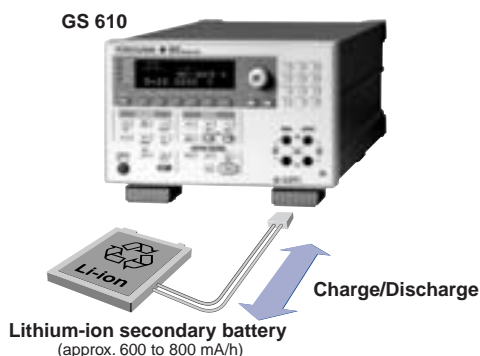

### Luminous Efficiency Measurement of Flat Panel Displays

The GS610 can be used to drive flat panel displays such as organic EL displays and surface emitting LEDs. To determine the drive conditions, the voltage-current characteristics and current-luminance characteristics of the display are measured using the GS610 and a luminance meter. From the measurement results, the operating point that maximizes the luminous efficiency (luminance and power consumption) is determined. The GS610 carries out pulse width modulation of the drive current at this operating point to control the luminance level of the display.

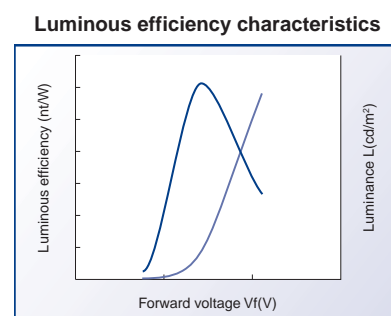
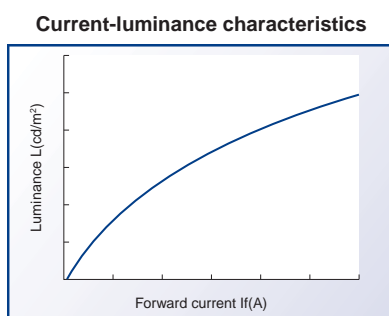
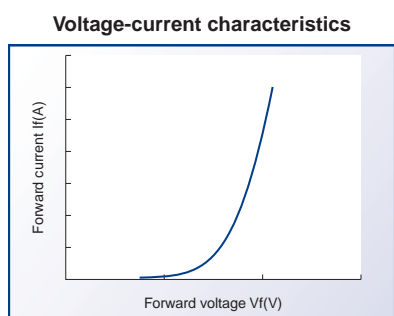
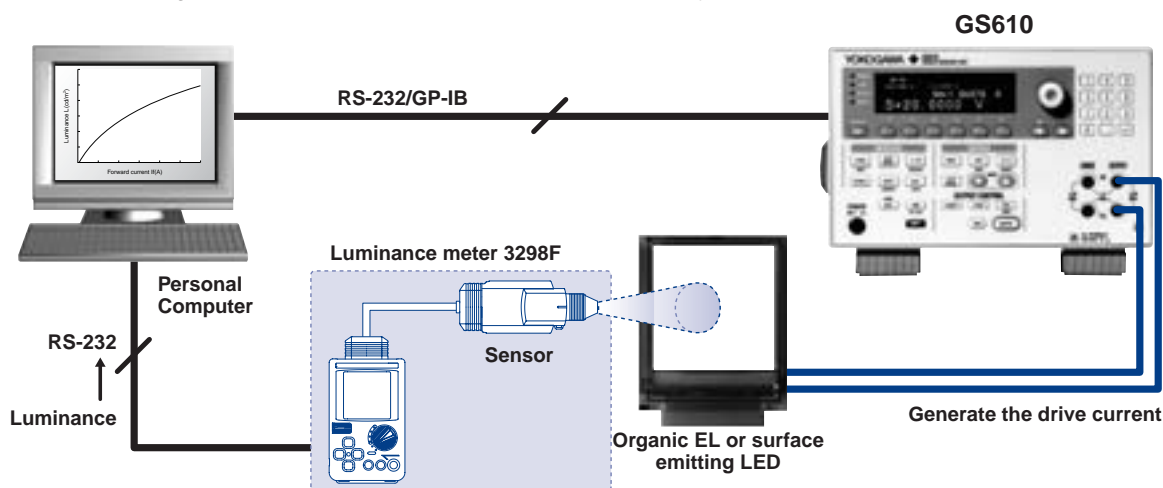

Generation Section

■ DC voltage generation

Range	Generation Range	Resolution	Max. Load Current	Accuracy (One Year) ±(% of setting + V + V <sup>10</sup> /f.s. of the limiter range)	Temperature Coefficient ±(% of setting + V + V <sup>10</sup> /f.s. of the limiter range)/°C
200 mV	±205.000 mV	1 μV	±3.2 A	0.02 + 200 μV + 80 μV (400 μV)	0.002 + 20 μV + 8 μV (40 μV)
2 V	±2.05000 V	10 μV	±3.2 A	0.02 + 300 μV + 100 μV (500 μV)	0.002 + 30 μV + 10 μV (50 μV)
12 V	±12.0000 V	100 μV	±3.2 A	0.02 + 2 mV + 800 μV (3 mV)	0.002 + 200 μV + 80 μV (300 μV)
20 V	±20.5000 V	100 μV	±2 A	0.02 + 2 mV + 800 μV (5 mV)	0.002 + 200 μV + 80 μV (500 μV)
30 V	±30.000 V	1 mV	±2 A	0.02 + 20 mV + 5 mV (30 mV)	0.002 + 2 mV + 500 μV (3 mV)
60 V	±60.000 V	1 mV	±1 A	0.02 + 20 mV + 6 mV (40 mV)	0.002 + 2 mV + 600 μV (4 mV)
110 V	±110.000 V	1 mV	±0.5 A	0.02 + 20 mV + 8 mV (70 mV)	0.002 + 2 mV + 800 μV (7 mV)

The values inside the parentheses are those when the limiter range is 3 A.

■ DC current generation

Range	Max. Output	Resolution	Max. Load Voltage	Accuracy (One Year) ±(% of setting + A)	Temperature Coefficient ±(% of setting + A)/°C
20 μA	±20.5000 μA	100 pA	±110 V	0.03 + 50 nA	0.003 + 5 nA
200 μA	±205.000 μA	1 nA	±110 V	0.03 + 300 nA	0.003 + 30 nA
2 mA	±2.05000 mA	10 nA	±110 V	0.03 + 3 μA	0.003 + 300 nA
20 mA	±20.5000 mA	100 nA	±110 V	0.03 + 30 μA	0.003 + 3 μA
200 mA	±205.000 mA	1 μA	±110 V	0.03 + 300 μA	0.003 + 30 μA
0.5 A	±0.50000 A	10 μA	±110 V	0.03 + 5 mA	0.003 + 500 μA
1 A	±1.00000 A	10 μA	±60 V	0.03 + 5 mA	0.003 + 500 μA
2 A	±2.00000 A	10 μA	±30 V	0.03 + 5 mA	0.003 + 500 μA
3 A	±3.20000 A	10 μA	±12 V	0.03 + 5 mA	0.003 + 500 μA

Accuracy: One year accuracy at 23±5 °C  
 Temperature coefficient: Add the temperature coefficient at 5 to 18 °C and 28 to 40 °C.

■ Current limiter

Setting *1	Range	Resolution	Min. Setting
0.10 μA ~ 20.000 μA	20 μA	10 nA	10 nA
20.1 μA ~ 200.0 μA	200 μA	100 nA	100 nA
0.201 mA ~ 2.000 mA	2mA	1 μA	1 μA
2.01 mA ~ 20.00 mA	20mA	10 μA	10 μA
20.1 mA ~ 200.0 mA	200mA	100 μA	100 μA
0.201 A ~ 3.20 A	3.2A	1 mA	1 mA

\*1 Larger of the two values |Hi| and |Lo| when |Hi limiter| ≠ |Lo limiter|

■ Voltage limiter

Setting *1	Range	Resolution	Min. Setting
1.0 mV ~ 200.0 mV	200 mV	100 μV	100 μV
0.201 V ~ 2.000 V	2 V	1 mV	1 mV
2.01 V ~ 20.00 V	20 V	10 mV	10 mV
20.1 V ~ 110.0 V	110 V	100 mV	100 mV

■ Transient response time (Typical)

Voltage generation

100 μs: Time to reach ±0.1% of final value \*1

at 20 V range with the generation and limiter settings at maximum values and under the 25% pure resistive load

\*1: In condition of zero voltage base pulse mode, measure delay time to reach ±0.1% of final value  
 Integration time 250 μs

Current generation

400 μs: Time to reach ±1% of final value \*1

at 20 mA range with the generation and limiter settings at maximum values and under the pure resistive load

\*1: In condition of zero current base pulse mode, measure delay time to reach ±1% of final value  
 Integration time 250 μs

■ Output Noise (Typical)

8 mVp-p (DC to 20 MHz)  
 (with generation at 2 V range and limiter at 1 A range)

## Measurement Section

### Voltage measurement

Range	Integration time 16.6ms/20ms,100ms,200ms				Integration time 4ms,1ms,250 μs			
	Measurement Range	Resolution	Accuracy (One Year) ±(% of reading + V)	Temperature Coefficient ±(% of reading + V) / °C	Measurement Range	Resolution	Accuracy (One Year) ±(% of reading + V)	Temperature Coefficient ±(% of reading + V) / °C
200 mV	±205.000 mV	1 μV	0.02 + 100 μV	0.002 + 10 μV	±205.00 mV	10 μV	0.02 + 200 μV (300 μV)	0.002 + 20 μV (30 μV)
2V	±2.05000 V	10 μV	0.02 + 200 μV	0.002 + 20 μV	±2.0500 V	100 μV	0.02 + 300 μV (500 μV)	0.002 + 30 μV (50 μV)
20 V	±20.5000 V	100 μV	0.02 + 1 mV	0.002 + 100 μV	±20.500 V	1 mV	0.02 + 3 mV (5 mV)	0.002 + 300 μV (500 μV)
110 V	±110.000 V	1 mV	0.02 + 10 mV	0.002 + 1 mV	±110.00 V	10 mV	0.02 + 30 mV (50 mV)	0.002 + 3 mV (5 mV)

### Current measurement

Range	Integration time 16.6ms/20ms,100ms,200ms				Integration time 4ms,1ms, 250 μs			
	Measurement Range	Resolution	Accuracy (One Year) ±(% of reading + A)	Temperature Coefficient ±(% of reading + A) / °C	Measurement Range	Resolution	Accuracy (One Year) ±(% of reading + A)	Temperature Coefficient ±(% of reading + A) / °C
20 μA	±20.5000 μA	100 pA	0.03 + 50 nA	0.003 + 5 nA	±20.500 μA	1 nA	0.03 + 70 nA (80 nA)	0.003 + 7 nA (8 nA)
200 μA	±205.000 μA	1 nA	0.03 + 300 nA	0.003 + 30 nA	±205.00 μA	10 nA	0.03 + 350 nA (400 nA)	0.003 + 35 nA (40 nA)
2 mA	±2.05000 mA	10 nA	0.03 + 3 μA	0.003 + 300 nA	±2.0500 mA	100 nA	0.03 + 3.5 μA (4 μA)	0.003 + 350 nA (400 nA)
20 mA	±20.5000 mA	100 nA	0.03 + 30 μA	0.003 + 3 μA	±20.500 mA	1 μA	0.03 + 35 μA (40 μA)	0.003 + 3.5 μA (4 μA)
200 mA	±205.000 mA	1 μA	0.03 + 300 μA	0.003 + 30 μA	±205.00 mA	10 μA	0.03 + 350 μA (400 μA)	0.003 + 35 μA (40 μA)
3 A	±3.20000 A	10 μA	0.03 + 5 mA	0.003 + 500 μA	±3.2000 A	100 μA	0.03 + 5.5 mA (6 mA)	0.003 + 550 μA (600 μA)

Accuracy: One year accuracy at 23±5 °C Auto zero ON.  
 Temperature coefficient: Add the temperature coefficient at 5 to 18 °C and 28 to 40 °C.  
 Values inside the parentheses are those when the integration time is 1 ms or 250 μs.

### Function

#### Generation

Generation function: Voltage or current

Generation mode: DC or pulse

Sweep mode: Linear, logarithmic, or program (up to 65535 steps)

#### Measurement

Measurement function: Voltage, current, and resistance

Measurement data storage: Up to 65535 data points

Average: Block average or moving average  
 (Specified count: 2 to 256)

#### Trigger

Trigger mode: Internal, external, and immediate

#### Time setting

Pulse width: 100 μs to 3600 s 1 μs resolution

Period time: 1 ms to 3600 s 1 μs resolution

(during source and measure operation)

100 μs to 3600 s 1 μs resolution

(during source-only operation)

Source delay: 1 μs to 3600 s 1 μs resolution

Measurement delay: 1 μs to 3600 s 1 μs resolution

Integration time: 250 μs, 1 ms, 4 ms, 16.6 ms/20 ms, 100 ms, 200 ms  
 (auto detect from the power supply frequency when the power is turned ON for 16.6 ms/20 ms)

#### Computation function

Operators: +[addition], -[subtraction], \*[multiplication], /  
 [division], and ^ [exponentiation]

Functions: ABS(), EXP(), LN(), LOG(), SQRT(), SIN(), COS(),  
 TAN(), ASIN(), ACOS(), ATAN(), SINH(), COSH(),  
 TANH(), RAND()

#### Resistance calculation

Calculated from measured voltage/generated current or generated voltage/  
 measured current.

### External Input/Output

#### Synchronization signal input/output section (TRIG/SWEEP/CTRL IN and OUT)

Connector type BNC connector

I/O level TTL

I/O logic format Negative logic, falling edge

Minimum pulse width 10 μs or greater

#### External input/output section

Connector type D-Sub 15-pin

I/O level TTL

I/O logic format Negative logic, falling edge

Minimum pulse width 10 μs or greater

#### GP-IB interface

Electrical and mechanical specifications  
 Conforms to IEEE St'd 488-1987

Functional specifications SH1, AH1, T6, L4, SR1, RL1, PP0, DC1, DT1, C0  
 Protocol Conforms to IEEE St'd 488.2-1987  
 Address 0 to 30

#### RS-232 interface

Connector type D-Sub 9-pin

Electrical specifications Conforms to EIA RS-232

Connection format Point-to-point

Transmission mode Full-duplex

Synchronization mode Start-stop synchronization

Baud rate 9600, 14400, 19200, 38400, 57600, or 115200 bps

#### USB interface

Number of ports 1

Connector type Type B connector (receptacle)

Electrical and mechanical specifications  
 Conforms to USB Rev. 1.1

#### Ethernet interface (optional)

Number of communication ports 1

Connector type RJ-45 connector

Electrical and mechanical specifications  
 Conforms to IEEE 802.3.

Transmission system 100BASE-TX/10BASE-T

Data rate 100 Mbps/10 Mbps

### General Specifications

Display: 256 x 64 dots vacuum fluorescent display

Internal memory:

ROM: 4MB Area for storing setup and output pattern files

RAM: 4MB Area for storing the measured results  
 (cleared when the power is turned OFF)

Warm-up time: At least 60 minutes

Operating conditions: 5 to 40 °C, 20 to 80% RH

Rated supply voltage:

100 to 120 VAC or 220 to 240 VAC (automatic switching)

Rated supply frequency: 50/60 Hz

Maximum power consumption:

Approx. 200 VA

Max. common-mode voltage:

±250 Vpeak between the generation  
 (measurement)  
 terminal and case

Max. Output/ input voltage:

110 V between High and Low terminal.  
 1 V between Output and Sense terminal.

Weight: Approx. 7 kg

External dimensions: Approx. 213 (W) × 132 (H) × 400 (D) mm  
 (excluding projections)

Model and Suffix Code

Model	Suffix Codes	Description
765501		GS610 Source Measure Unit
Power cord	-D	UL/CSA standard
	-F	VDE standard
	-R	AS standard
	-Q	BS standard
	-H	GB standard
Option	/C10	Ethernet interface

Note: Test certificate and calibration certificate are provided only at the time of the order. They cannot be issued after the product has been delivered.

Optional Accessories for GS610

Model	Product	Description
758933	Measurement lead set	1m, 2 leads(red and black) in a set,
758917	Measurement lead set	75cm, 2 leads(red and black) in a set,
758922	Alligator clip adapter set	Rating 300 V, 2 adapters in a set
758929	Alligator clip adapter set	Rating 1000 V, 2 adapters in a set
701959	Safty Mini-clip (Hook Type)	Hook type, 2 clips(red and black) in a set
758924	BNC adapter	BNC-banana conversion
701901	1:1 BNC safety adapter lead	1000 Vrms-CATII, 1.8 m
701902	Safety BNC-BNC cable	1.0 m
701903	Safety BNC-BNC cable	2.0 m
758923	Safety terminal adapter set	Spring-hold type, 2 adapters(red and black) in a set
758931	Safety terminal adapter set	Screw lock type, 2 adapters(red and black) in a set

Rack Mount

Model	Product	Description
751533-E3	Rack mounting kit	For EIA, single mounting
751533-J3	Rack mounting kit	For JIS, single mounting
751534-E3	Rack mounting kit	For EIA, double mounting
751534-J3	Rack mounting kit	For JIS, double mounting

Standard Accessories

Power cord, 758933 measurement lead (1 set with red and black lines), 758922 alligator clip adapter (small) (1 set with red and black pcs.), and a set of instruction manuals

Dimensions

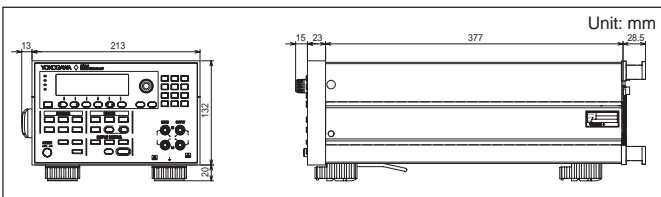

Microsoft Windows, Excel and Internet Explorer are either registered trademarks or trademarks of Microsoft Corporation in the United States and/or other countries.

Optional Accessories



**758933 Measurement lead set**

2 pieces (red and black) in 1 set, length: 1.00 m Used in combination with the 701959, 758921, 758922, or 758929. Rating: 1000 V CAT III/19 A



**758917 Measurement lead set**

2 pieces (red and black) in 1 set, length: 0.75 m Used in combination with the 701959, 758921, 758922, or 758929. Rating: 1000 V CAT II/32 A



**758922 Small Alligator clip adapter set** ⚠

Safety terminal (banana female)-to-alligator clip adapter 2 pieces (red and black) in 1 set Rating: 300 V CAT II Connected to the 758933, 758917, or 701901.



**758929 Large Alligator clip adapter set** ⚠

Safety terminal (banana female)-to-alligator clip adapter 2 pieces (red and black) in 1 set Rating: 1000 V CAT II Connected to the 758933, 758917, or 701901.



**701959 Safety Mini-clip set (Hook Type)** ⚠

Safety terminal (banana female)-to-mini clip adapter 2 pieces (red and black) in 1 set Rating: 1000 V CAT II Connected to the 758933, 758917, or 701901.



**758924 BNC adapter**

Safety terminal (banana female)-to-BNC (male) adapter Connected to the 758933, 758917, or 701901.



**701901 1:1 BNC safety adapter lead**

Safety BNC (male)-to-safety terminal (banana male) Used in combination with the 701959, 758921, 758922, or 758929. Rating: 1000 V CAT II



**701902/701903 Safety BNC-BNC cable**

701902: Length 1 m, 1000 V CAT II  
701903: Length 2 m, 1000 V CAT II



**758923 Safety terminal adapter set**

Spring-hold type (banana male) 2 pieces in 1 set. \*1  
Easy attachment/detachment of the cable.



**758931 Safety terminal adapter set**

Screw-fastened type (banana male) 2 pieces in 1 set. \*1  
Comes with a B9317WD 1.5 mm hexagonal wrench for fixing the cable in place.

\*1 Wire diameter of cables that can connect to the adapter  
758923 Core wire diameter: 2.5 mm or less, covering diameter: 5.0 mm or less  
758931 Core wire diameter: 1.8 mm or less, covering diameter: 3.9 mm or less

⚠ Due to the nature of the product, it is possible for the user to come in contact with metal parts and receive electric shock. Exercise caution when using the product.



**YOKOGAWA ELECTRIC CORPORATION**  
Communication & Measurement Business Headquarters /Phone: (81)-422-52-6768, Fax: (81)-422-52-6624  
E-mail: tm@csv.yokogawa.co.jp

**YOKOGAWA CORPORATION OF AMERICA** Phone: (1)-301-916-0409, Fax: (1)-301-916-1498  
**YOKOGAWA EUROPE B.V.** Phone: (31)-33-4641858, Fax: (31)-33-4641859  
**YOKOGAWA ENGINEERING ASIA PTE. LTD.** Phone: (65)-62419933, Fax: (65)-62412606

Subject to change without notice.  
[Ed : 01/b] Copyright ©2005  
Printed in Japan, 507(KP)